

Platinum High Bay Slimline Series 200w & 240w



DESCRIPTION:

Touch-Plate's Slimline High Bay was designed to provide higher lumens and even light distribution. Using up to 70% less power over traditional metal halide or high pressure sodium lighting. Our Slimline High Bay is optimal for any application that requires a High Bay.

PRODUCT FEATURES:

- Instant Start: no flickering or humming
- Uniform Light
- Isolated driver
 - Round driver rated for 60°C (140°F)
 - Square driver rated for 90°C (194°F)
- Die cast aluminum housing
- Lifetime of 50,000 hrs or greater
- UL Listed (E493410)
- DLC Listed
 - 200w (DHB_200)
 - 240w (DHB_240)
- 5 Year Limited Warranty

SPECIFICATIONS:

- Wattage: 200w & 240w
- Lumens: 28,000 & 31,200 (approx > 140lm/w)
- Equivalence: 500w & 600w HID/HPS/MH
- IP Rating: IP65
- IK Rating: IK08
- LED Chips: SMD 3030
- PF: >0.90

PHYSICAL PARAMETERS:

- Dimensions
 - Diameter: 15.35"
 - Hook Height: 7.08"
 - Bracket Height: 11.68"
- Weight
 - 16.4lbs (200w & 240w)

7.08"

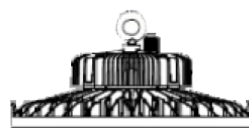

15.35"

11.68"

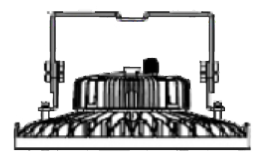

15.35"

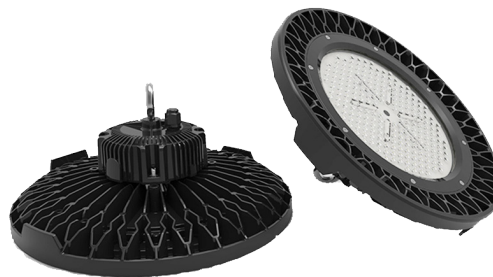

Platinum High Bay Slimline Series

ORDERING GUIDE

LED Type XXX-	Lumens - Wattage XXX-XXX-	CCT XX	Voltage X	Color X
<ul style="list-style-type: none"> HBS High Bay Slimline 	<ul style="list-style-type: none"> 280-200 28,000lm - 200w 312-240 31,200lm - 240w 	<ul style="list-style-type: none"> 40 4000k 45 4500k 50 5000k 57 5700k 	<ul style="list-style-type: none"> U 120-277v I 200-480v 	<ul style="list-style-type: none"> B Black W White

ADDITIONAL ORDERING OPTIONS

(specified at time of order)

Lens Options

- Clear Glass (Standard)
- Milky Glass

Beam Angle

- 30°
- 60°
- 90°
- 120° (TP Standard)

ACCESSORIES

(specified at time of order)

- | | | |
|---|--|--|
| <ul style="list-style-type: none"> • Wire Guard • Diffuser • Occupancy Sensor • Photocontrol Sensor | <ul style="list-style-type: none"> • Zigbee Relay • Zigbee Dimmer • Zigbee Controller | <ul style="list-style-type: none"> • Stainless Steel Cable: 2ft / 3ft / 7ft / 10ft / 20ft • Twist Lock Plug: 3ft / 10ft • No Plug Extension: 3ft / 10ft • USA 3 Prong Plug: 7ft • S Hook Clip: Medium / Large • Connection Box: Small / Large • Connector: 3-Pin Splice |
|---|--|--|

PHOTOMETRIC

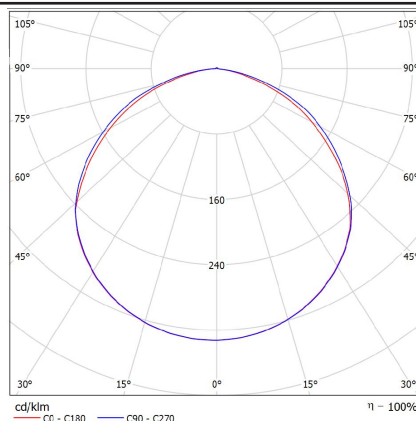

Platinum High Bay Slimline Series

INSTALLATION INFORMATION (WIRING)

This product must be installed in accordance with National Electrical Code(NEC) and/or applicable local codes, by a qualified electrician.

DANGER - RISK OF SHOCK - DISCONNECT POWER BEFORE INSTALLATION

- High Bays can be ordered with a specified twist lock plug or without a plug
- Plug in the High Bay or make the necessary 'HOT' (Black or Brown), 'Neutral' (White or Blue), and 'Ground' (Green) connections in an approved junction box.

INSTALLATION INFORMATION

Hanging Mounting

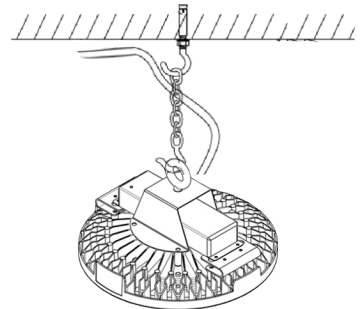
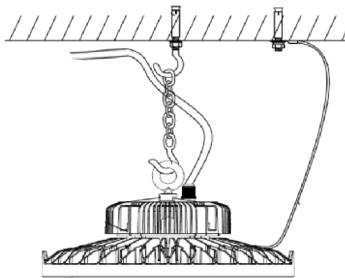

Wall Mounting

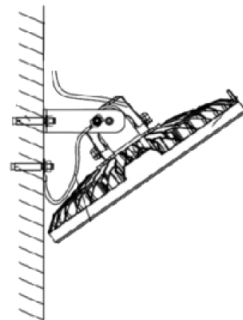

Pipe Mounting

